



PRODUCT DATA SHEET

Appearance & Shape: To be free from any defect such as flow, burrs, unevenness etc; as per IEC standards

Effective parameters irrespective of material grade (per set)

Parameter	Value	Unit
Effective Length (L_e)	70.0	mm
Effective Area (A_e)	200	mm ²
Effective Area (A_{Min})	170	mm ²
Effective Volume (V_e)	14000	mm ³
Approx. Weight (without gap)	77.3	g/set



RM14 Un-gapped (OL)

Test Conditions: 1kHz/1mT/CFR COIL,N=100/25°C

Material Grade	Initial Permeability (μ_{iac})	AL Value (nH)/Set	P_v (W/set)	Ordering code
CF139	2100 \pm 20%	5400 +30%/-20%	\leq 1.4 (100mT,100kHz,100°C)	CF139 RM14 OL
CF297	2300 \pm 20%	5650 +30%/-20%	\leq 1.26 (100mT,100kHz,100°C)	CF297 RM14 OL

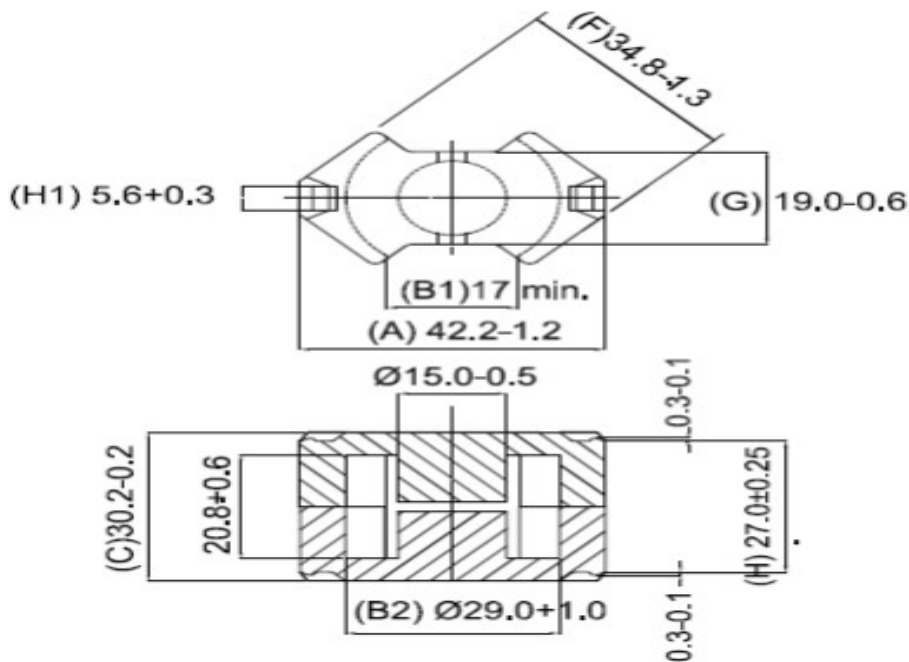

Remarks: Value of "G" is Zero (0) for Un-Gapped Cores, for Gapped Cores the value of "G" varies as per the Gap/AL value



Prodin Ferrite S.L.

Calle A, 27, 08620 Sant Vicenç dels Horts, Barcelona (Spain)

Tel.: +34 93 672 46 10

info@prodinferrite.com www.prodinferrite.com